

Aprilaire®

Welcome to a Healthy Home

**ALLERGY+
PET9550™**

READ AND SAVE THESE INSTRUCTIONS





Trusted solutions for a healthy home.

Delivering healthier indoor air has been our business since 1954.

For over 60 years, HVAC professionals have made Aprilaire their trusted choice for indoor air quality solutions, including: air purification, ventilation, humidification, and temperature control. Our network of top quality dealers has installed millions of air purifiers in homes across North America and sold tens of millions of genuine Aprilaire replacement filters.

With the introduction of the Aprilaire 9550 series, we are proud to bring our legacy of quality, features, and innovation to portable room air purifiers.





Improving the indoor air quality in your home, starts with Aprilaire — the leader in Indoor Air Quality (IAQ) solutions.

What is Indoor Air Quality?

IAQ refers to the condition of the air in your home. The aspects of IAQ include: **temperature, humidity, air purity and ventilation**. When these conditions aren't properly managed, it can lead to poor indoor air quality which can impact the health and wellness of you and your family. According to the U.S. E.P.A., the air inside your home can be up to ten times more polluted than the air outside.

Temperature

Temperature plays an essential role in comfort and health. With improved programmability, Wi-Fi and zoned controls, comfort can be improved while preserving energy efficiency.

Humidity

The relative humidity in the home can impact asthma, allergies and skin conditions and increase the incidence of cold and flu. Control of humidity also protects against mold growth, odors and damage to the home.

Air Purity

Air purification protects your family's health (as well as your HVAC system) from harmful particulates like allergens, mold spores, dust mites and viruses.

Ventilation

Stale air leads to odors, increased humidity and a high concentration of Volatile Organic Compounds (VOCs). Without proper ventilation, comfort and health are at risk.

A Cleaner Home Starts Here

Create a no-fly zone for airborne allergens – including those from your pets, with the Aprilaire Allergy + Pet9550. Its 4-stage True HEPA filtration system is 99.97%* effective at helping to remove visible and invisible airborne impurities and allergens. It has a special filter designed to remove allergens specific to pets, like fine hair and dander. The full filtration system helps to remove dust, pollen, germs, mold spores, and odors, all of which can trigger allergy and even asthma symptoms including sneezing, coughing, and watery eyes.



*Particles 0.3 microns and larger in size.

Congratulations on your purchase of a genuine Aprilaire Air Purifier. You're making an investment in one of the most important aspects of health and wellness—the air you and your family breathe.

In this User Manual you'll find step-by-step instructions for operation and maintenance, along with answers to common questions. Take a look around and discover how you can get the most out of your new Aprilaire Air Purifier.

TABLE OF CONTENTS

About Us	1
Safety Instructions	7
A Closer Look at Your Air Purifier	9
The Control Panel	12
Placement of Your Air Purifier	15
Initial Air Purifier Set-up	17
Care & Maintenance	19
Troubleshooting Tips	25
Answers to Frequently Asked Questions	26
Warranty	28

IMPORTANT SAFETY INSTRUCTIONS

READ AND SAVE THESE INSTRUCTIONS BEFORE USING THIS AIR PURIFIER

WARNING: Failure to follow these instructions can result in fire, electric shock, injury or property damage.

- Read all the instructions before operating the air purifier.
- Remove plastic shipping bag from filter(s) before turning the unit on. Keep the plastic shipping bag away from children.
- This appliance has a polarized plug (one blade is wider than the other). To reduce the risk of electric shock, this plug is intended to fit in a polarized outlet only one way. If the plug does not fit fully in the outlet, reverse the plug. If it still does not fit, contact a qualified electrician. Do not attempt to defeat this safety feature.
- Use only with 110-120 VAC outlet. Be sure unit is plugged in firmly and completely. As with any electrical device, plug and unplug the air purifier with dry hands only.
- Do not operate air purifier with a damaged cord or plug.
- Do not run cord under carpeting. Do not cover cord with throw rugs, runners, or similar coverings. Do not route cord under furniture or appliances.
- Arrange cord away from traffic areas and place cord where it will not be stepped on or tripped over.
- Keep the power cord away from heated surfaces.
- Do not use an extension cord.
- Do not pull on the cord to remove the plug from the outlet. Grip plug and pull from the outlet.

- Always turn OFF the air purifier before unplugging the cord from the power supply.
- Always unplug or disconnect the air purifier from the power supply before servicing.
- WARNING: To reduce the risk of fire or electric shock, do not use this air purifier with any solid-state speed control device.
- Do not operate the air purifier where combustible products are present.
- Turn the air purifier OFF and unplug the unit when not in use or before moving.
- Do not operate the air purifier if it malfunctions, has been dropped, or is damaged.
- Do not operate the air purifier outdoors. Do not operate the air purifier in a bathroom, laundry area or any other damp location.
- Never place the air purifier in water or other liquids as electrical shock may occur.
- Do not place the air purifier on soft surfaces. Place the air purifier on a flat, level surface.
- Keep the air purifier at least 12” away from any heat sources.
- Only operate the air purifier in the upright position.
- Do not allow foreign objects to enter the intake or exhaust openings on the air purifier.
- Do not block or cover the intake or exhaust openings of the air purifier in any manner.
- Do not stand, sit, or place heavy objects on the air purifier.
- Never try to take apart or repair the air purifier.



Intertek

ETL tested for safety.

**This air cleaner complies
with the federal ozone
emissions limit.**

ARB CERTIFIED

A Closer Look At Your Air Purifier

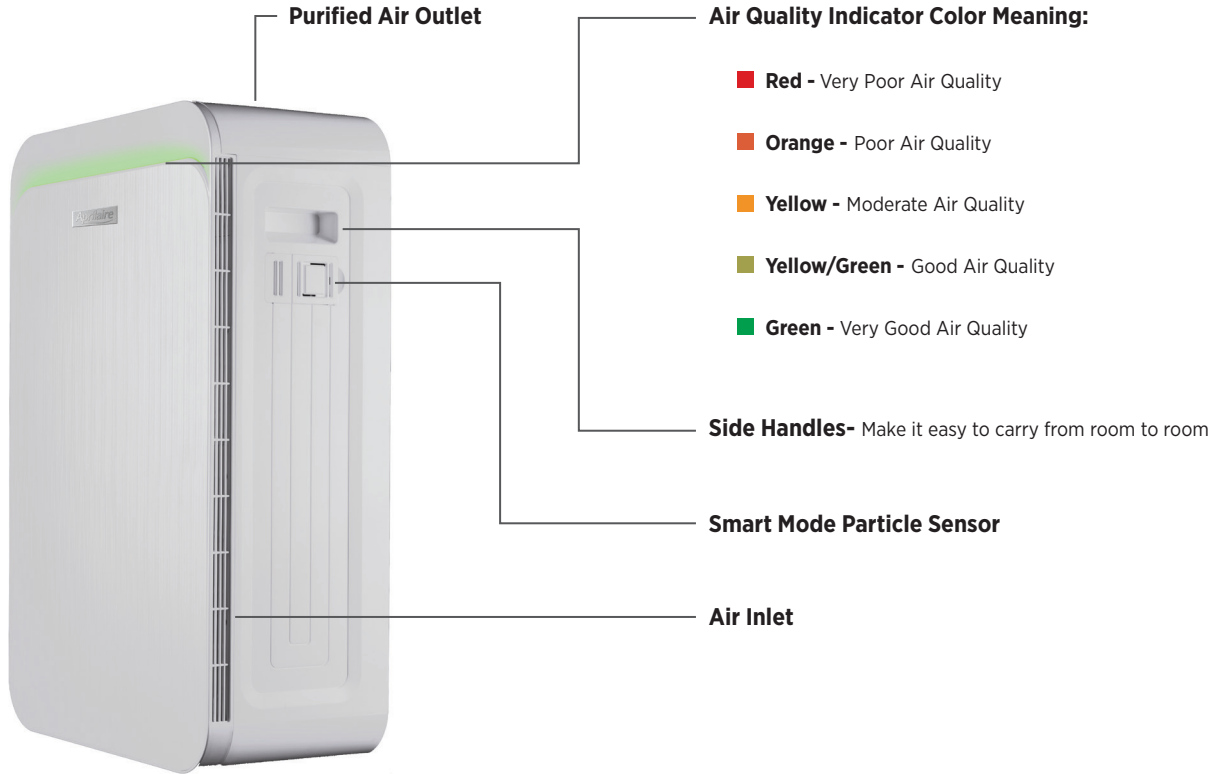

4-Stage Filtration System



Pre-filter

Captures large to medium airborne particles

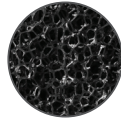

Pet filter

Traps fine airborne pet hair & dander

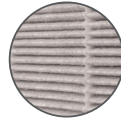

True HEPA Type Filter

Removes 99.97% airborne allergens, including pet dander, pollen, mold spores, germs, & other pollutants larger than 0.3 microns



Alumina Oxide + Activated Carbon Bed Filter

Helps remove pet odors, VOCs, & gaseous allergy triggers

Front Cover

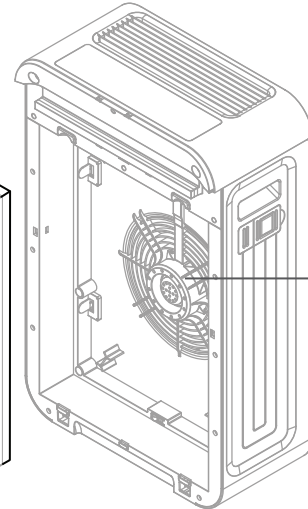
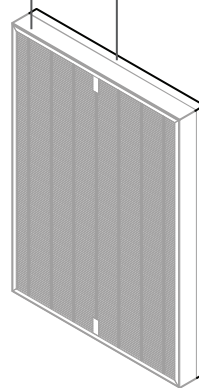
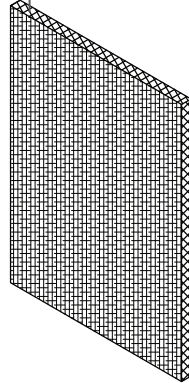
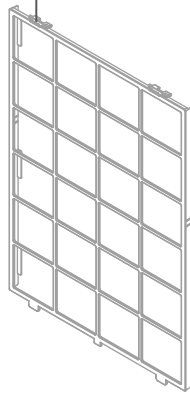

Fan
Powerful 6 speed fan

Top View

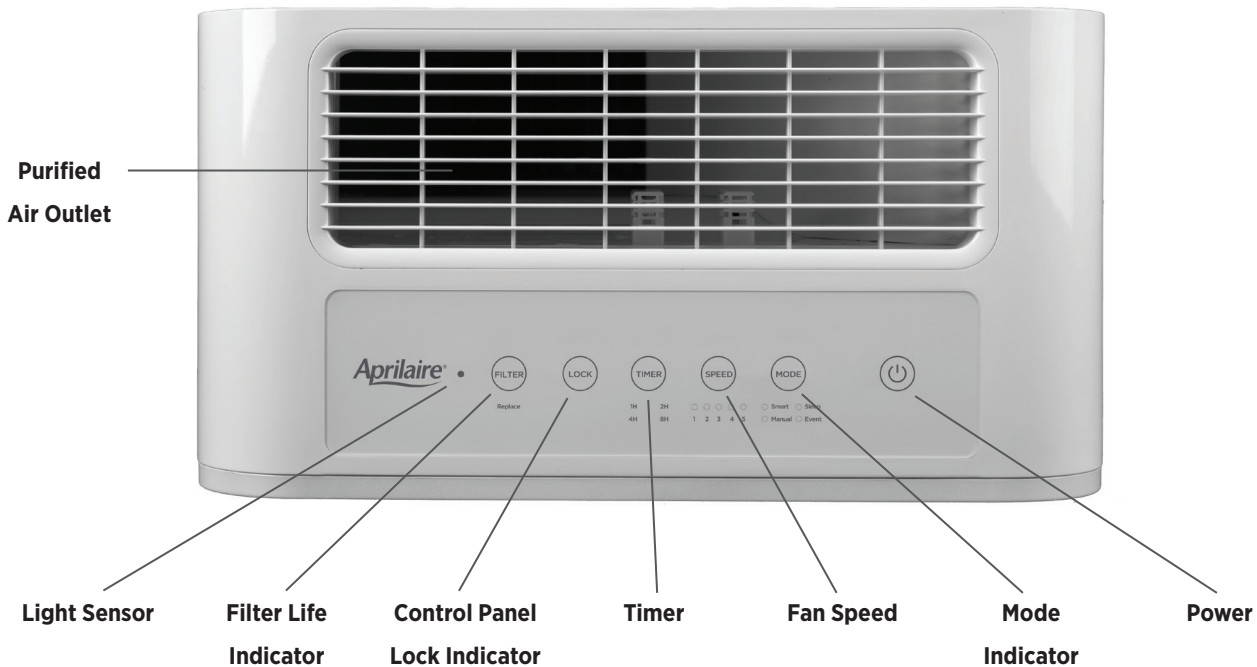

The Control Panel

- 1. Power** Press the  button to start the air purifier. (This button will also shut it off.)
 - The air purifier will beep 1 time when powered on.
 - The air purifier will automatically start in Smart Mode.
- 2. Air Quality Indicator Light** The light bar on the front of the air purifier changes color to indicate the current air quality level as measured by the Smart Mode Particle Sensor. It moves from red to yellow to green as the air quality improves.
- 3. Four Operating Modes**

Smart Mode

In Smart Mode, the fan speed adjusts automatically to improve indoor air quality based on the Smart Mode Particle Sensor reading. The fan speed is faster when particle levels are high, and will slow down as air quality improves. The Air Quality Indicator Light on the front of the air purifier changes color to indicate the current air quality level.

Manual Mode

In Manual Mode, press the Speed button to manually adjust the fan speed.

Sleep Mode

In Sleep Mode, the fan speed automatically adjusts to Low (1), the Air Quality Indicator Light turns off, the control panel lights dim, and the Timer counts down from 8 hours. The air purifier will automatically turn off when the selected time expires.

In Sleep Mode you can manually adjust the fan Speed and Timer using the control panel.

Turbo Mode

In Turbo Mode, the fan Speed automatically adjusts to Turbo Purifying (6) for maximum cleaning power. The lights on Fan Speed turn off. You can manually set the Timer for the length of Turbo Purifying you want, and/or Lock the setting.

4. Fan Speed

Press the Speed button to manually adjust the fan speed from the Sleep or Manual modes.

1. Whisper Quiet Purifying
2. Light Pet Allergen
3. Moderate Pet Allergen
4. Heavy Pet Allergen
5. Extra-Heavy Pet Allergen
6. Turbo Purifying

5. Timer

Press the Timer button to choose a length of operation: 1, 2, 4, or 8 hours. When the set time expires, the air purifier automatically turns off.

6. Control Panel Lock

The Lock button locks the Control Panel in the current setting.

To engage the Lock, press and hold the Lock button for 5 seconds. The air purifier will beep 3 times, and the Lock button will light up.

If the control panel is set to Sleep Mode, the air purifier will not beep when the Lock button is pressed.

To unlock, press and hold the Lock button for 6 seconds. The Lock button light will turn off and the air purifier will beep 3 times.

Alternative: Easily unlock the air purifier by simply unplugging the unit, then plugging it back in. This will also turn off the Lock button light.

7. Filter Life Indicator

When the Filter Cartridge is at 90% of its capacity, the air purifier will beep 3 times when the power is turned on indicating it is time to order a new filter cartridge. The Filter button will flash until the Filter Cartridge is replaced and the Filter Life Indicator is reset.

To reset the Filter Life Indicator, press and hold the Filter button for 5 seconds. The air purifier will beep 3 times and the light for the Filter button will turn off.



To order a replacement filter cartridge, go to Aprilaire.com or call 800.931.0014.

8. Light Sensor

If the room is dark for more than 3 minutes, the air purifier will automatically go into Sleep Mode. When that occurs, you can still adjust the fan Speed and Timer, and use the Lock function.

Placing Your Air Purifier

Deciding where to place your air purifier is all about safety and airflow. Follow the simple steps below to get the most out of your investment.

- Thoroughly read and follow the Safety Instructions in this User Manual.
- As a general rule, you should allow 1 to 2 feet of open space on all sides of your air purifier, including the top. Air enters through vents on the sides of the unit. Keep these areas free from obstruction at all times for maximum cleaning efficiency.
- The Aprilaire 9550 was designed to draw impure air through side vents, expelling purified air through the top vent so it can be placed near a wall.
- Avoid placing the air purifier in a corner. This makes it more difficult to efficiently clean the air throughout the entire space.
- Air purifiers are designed to effectively clean the air in a room that's closed to other rooms and the outdoors. So avoid areas where new, impure air is continually introduced, as this can significantly reduce the efficiency of the air purifier.

Bedroom Overhead View

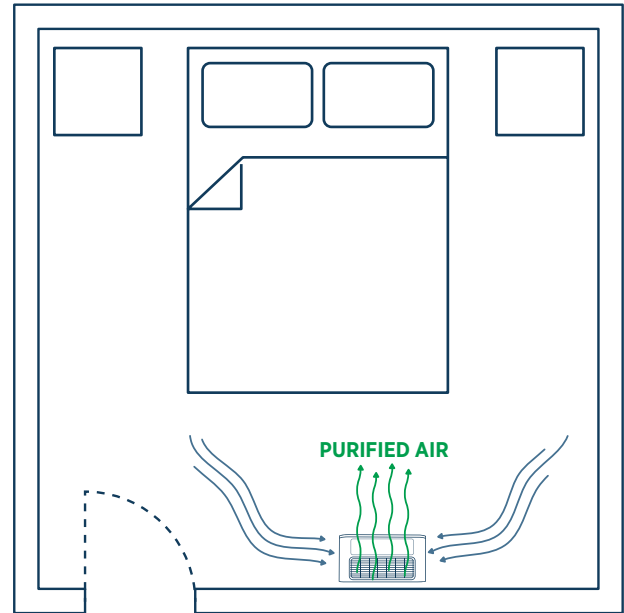



$e=mc^2$

W

mystery load
imaginary lines
Uncle Walt

完全蓄
100 liter
1.4 quart per
IG 207
Speed 64 mph
vertical 12 ft
Deceased
with large
Diameter high



班

Initial Set-up

Let The Freshness Begin

1. **IMPORTANT:** For the initial setup, ensure the air purifier is not plugged into an electrical outlet.
2. Remove the front cover of the air purifier by pulling the front panel away from the purifier, as shown in figure **A**.
3. Remove the Pre-filter, including the black Fine Pet Hair & Dander Trap, by pressing down on the top tabs and pulling back, as shown in figure **B**. Remove the protective plastic bag from the black Fine Pet Hair & Dander Trap and recycle or discard it.
4. Remove the Filter Cartridge from inside the air purifier, remove its protective plastic bag and recycle or discard it.
5. Place the Filter Cartridge back inside the air purifier so:
 - a. You can see the words “This Side Out” printed on the top of the Filter Cartridge frame.
 - b. The fabric tab is facing outward so you can use it to easily remove and replace the Filter Cartridge in the future.
6. Return the black Fine Pet Hair & Dander Trap to the Pre-filter.
7. Return the Pre-filter containing the black Fine Pet Hair & Dander Trap to the air purifier by first inserting the 3 tabs on the bottom, then pinching and inserting the 2 tabs on the top until it snaps into place.
8. Return the front cover panel by inserting the 2 tabs on the bottom and tilting the cover upward to set it in place at the top. The front cover should be flush with the top of the air purifier.
9. Plug in the air purifier to an electrical outlet to begin air purification.

Figure A

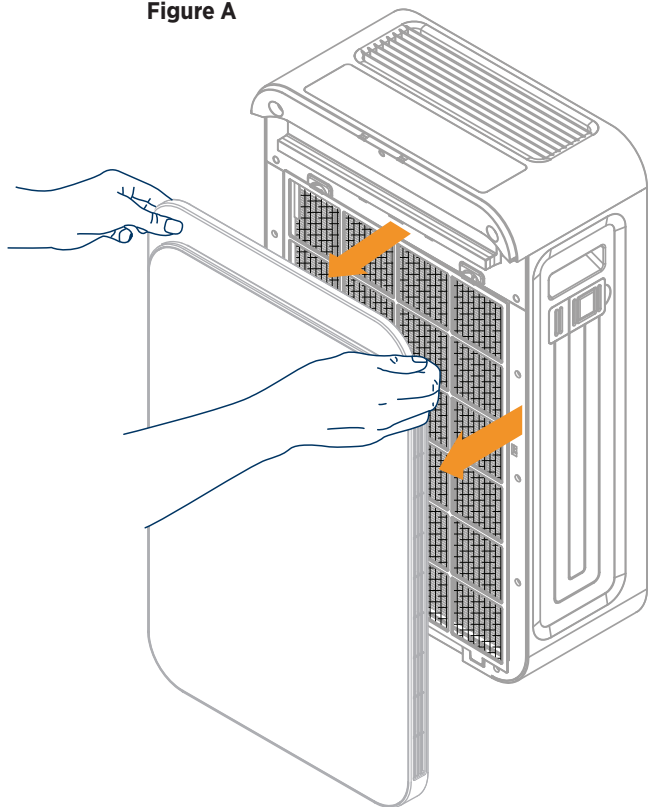
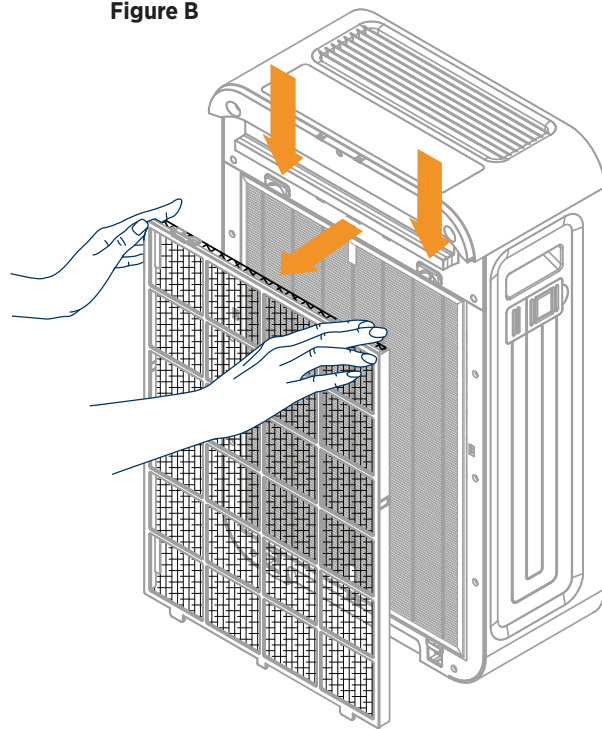

Figure B



Care & Maintenance

Fresh Filter = Fresh Air

Top reasons you should replace your Filter Cartridge on schedule:

1. Optimize your air quality for the health and wellness of you and your family
2. Maximize the longevity of your Air Purifier
3. Fulfill a term of the Aprilaire® Air Purifier Limited Warranty

Filter Life Expectancy

An Aprilaire Filter Cartridge will last about 6 – 12 months, depending on usage.

Filter Replacement Notification

When the filter is at 90% of its capacity, the air purifier will beep 3 times when the power is turned on. This indicates it is time to order a new Filter Cartridge. The Filter button will flash until the filter is replaced and the Filter Life Indicator is reset.

How to Order a New Filter Cartridge



To order a replacement filter cartridge, go to [Aprilaire.com](https://www.aprilaire.com) or call 800.931.0014.

How To Clean the Pre-filter and Fine Pet Hair & Dander Trap

On a monthly basis, we recommend you check the Pre-filter and the Fine Pet Hair & Dander Trap for visible particle build-up. If you see any, simply clean the filters using the steps below.

Note: Do NOT clean or wash the Filter Cartridge. This will make it unusable.

1. **IMPORTANT:** First, unplug the air purifier from the electrical outlet.
2. Remove the front cover of the air purifier by pulling the front panel away from the purifier, as shown in figure **A**.
3. Remove the Pre-filter, including the black Fine Pet Hair & Dander Trap, by pressing down on the top tabs and pulling back, as shown in figure **B**.
4. Remove the black Fine Pet Hair & Dander Trap from the Pre-filter.
5. Gently vacuum the Pre-filter and the Fine Pet Hair & Dander Trap, as shown in figure **C**. If visible build-up remains, use soap and water to gently wash the filters. (Reminder: Do not clean or wash the Filter Cartridge.)
6. **IMPORTANT:** Completely dry the Pre-filter and the Fine Pet Hair & Dander Trap before re-installing them.
7. When completely dry, return the black Fine Pet Hair & Dander Trap to the Pre-filter.
8. Replace the Pre-filter containing the black Fine Pet Hair & Dander Trap to the air purifier by first inserting the 3 tabs on the bottom, then pinching and inserting the 2 tabs on the top until it snaps into place.
9. Replace the front cover panel by inserting the 2 tabs on the bottom and tilting the cover upward to set it in place at the top. The front cover should be flush with the top of the air purifier.
10. Plug in the air purifier to an electrical outlet to resume air purification.

Figure A

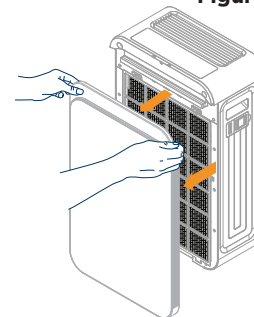

Figure B

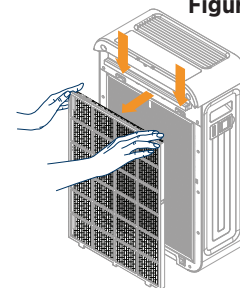
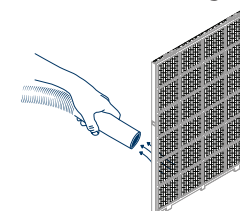

Figure C



How To Replace the Fine Pet Hair & Dander Trap and the Filter Cartridge

The Filter Cartridge should be replaced every 6-12 months, depending on usage.

1. **IMPORTANT:** First, unplug the air purifier from the electrical outlet.
2. Remove the front cover of the air purifier by pulling the front panel away from the purifier, as shown in figure **A**.
3. Remove the Pre-filter, including the black Fine Pet Hair & Dander trap, by pressing down on the top tabs and pulling back, as shown in figure **B**.
4. Remove the protective plastic bags from the replacement Fine Pet Hair & Dander Trap and the Filter Cartridge.
5. Remove the black Fine Pet Hair & Dander Trap from the Pre-filter. Pull the fabric tab on top of the used Filter Cartridge to remove it from the air purifier.
6. Place the used black Fine Pet Hair & Dander Trap and Filter Cartridge into the plastic bag to contain the accumulated particulates and discard.
7. Place the Filter Cartridge in the air purifier so:
 - a. You can see the words “This Side Out” printed on the top of the Filter Cartridge frame.
 - b. The fabric tab is facing outward so you can use it to easily remove and replace the Filter Cartridge in the future.
8. Place the new Fine Pet Hair & Dander Trap in the Pre-filter.
9. Return the Pre-filter containing the black Fine Pet Hair & Dander Trap by first inserting the 3 tabs on the bottom, then pinching and inserting the 2 tabs on the top until it snaps into place.

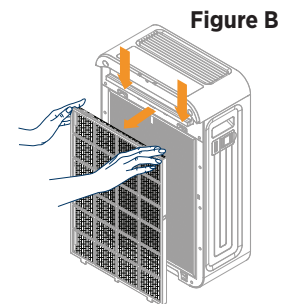
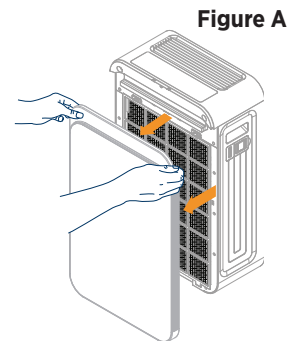

10. Replace the front cover panel by inserting the 2 tabs on the bottom and tilting the cover upward to set it in place at the top. The front cover should be flush with the top of the air purifier.
11. Plug in the air purifier to an electrical outlet to resume air purification.
12. To reset the Filter Life Indicator, press and hold the Filter button for 5 seconds. The air purifier will beep 3 times and the light for the Filter button will turn off. Plug in the air purifier to an electrical outlet to resume air purification.



WARNING! RISK OF ELECTRIC SHOCK - These servicing instructions are for use by qualified personal only. To reduce the risk of electric shock, do not perform any servicing other than that contained in the operating instructions unless you are qualified to do so.

How To Reset the Filter Life Indicator

After replacing the Filter Cartridge, you can reset the Filter Life Indicator by pressing and holding the Filter button for 5 seconds. The air purifier will beep 3 times and the light for the Filter button light will turn off.

Cleaning the Smart Mode Particle Sensor

Particles can build up on the particle sensor and prevent it from accurately measuring the air quality in your room. To keep your air purifier performing optimally, the particle sensor should be cleaned every time the Filter Cartridge is replaced.

1. **IMPORTANT:** First, unplug the air purifier from the electrical outlet.
2. Open the white access door on the right side panel of the air purifier. You will see a small black door.
3. Open the small black tab to gain access to the particle sensor lens.
4. Lightly moisten one end of a cotton swab with water. Use the wet end of the cotton swab to gently clean off the particle sensor lens.
5. Use the dry end of the cotton swab to dry the particle sensor lens.
6. Close the black door to the particle sensor lens. The particle sensor will still work if the black door is not completely closed.
7. Close the door on the side panel of the air purifier.
8. Plug in the air purifier to an electrical outlet to resume air purification.





Troubleshooting Tips

I plugged in and turned on my new Aprilaire Air Purifier for the first time, but no air is coming out.

Refer to page 17 for instructions on the initial setup of your new air purifier.

My Aprilaire Air Purifier beeps 3 times every time I turn it on. What does that mean?

If the beeping happens at the same time the Filter button is illuminated, it's time to order a new Filter Cartridge.

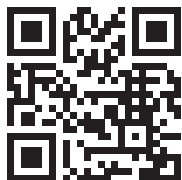

To order a replacement filter cartridge, go to [Aprilaire.com](https://www.aprilaire.com) or call 800.931.0014.

Go to page 21 to learn how to change the Filter Cartridge and reset the Filter Life Indicator.

I put in a new filter but the Filter button is still illuminated and flashing.

Any time you replace the filter, you should also reset the Filter Life Indicator. To do this, press and hold the Filter button for 5 seconds. The air purifier will beep 3 times and the Filter button light will turn off.

My Aprilaire Air Purifier always runs on the highest speeds when in Smart Mode.

This may occur for two reasons:

- The surrounding air is dirty and needs to be purified at the highest setting.
- The particle sensor lens has dust on it and needs to be cleaned. See “How To Clean the Particle Sensor” on page 23.

Answers To Frequently Asked Questions

What are the electric specifications for my air purifier?

Refer to the rating label on the back of the unit. There you will find your air purifier's voltage, hertz, amps and outlet requirements.

Can I clean the Pre-filter?

Yes. The Pre-filter, which captures large dust particles and hair, can be gently vacuumed to remove buildup. If buildup remains, you can gently wash the Pre-filter with soap and water. IMPORTANT: The Pre-filter must be completely dry before it's placed into the air purifier. Refer to page 20 for instructions on cleaning the pre-filter.

Can I clean the Fine Pet Hair & Dander Trap?

Yes, you can gently vacuum the Fine Pet Hair & Dander Trap to remove build-up. If build-up remains, you can gently wash the trap with soap and water. IMPORTANT: The Fine Pet Hair & Dander Trap must be completely dry before it's placed back into the air purifier.

Can I clean the HEPA and activated carbon filter cartridge?

No, this filter cannot be cleaned or reused.

To optimize the performance of your Aprilaire air purifier and fulfill a term of the Aprilaire Limited Warranty, make sure to replace the filter when notified by the Filter Life Indicator. (More information on page 14.)

Does this air purifier produce ozone?

No. Unlike many room air purifiers, the Aprilaire 9550 does not contain an ionizer so it does not produce even a small amount of ozone. It was designed with a non-arcing motor and therefore does not produce any ozone as an operational byproduct.

I have additional questions not covered in this User Manual.

Please contact the party from whom you purchased the Aprilaire air purifier, or visit Aprilaire.com.



Aprilaire

LIMITED WARRANTY

Warranty Registration

Visit Aprilaire.com to register your Aprilaire air purifier for warranty.

Your Warranty Registration information will not be sold or shared outside of this company.

Warranty Inquiry

For a warranty claim, contact the party from whom you purchased the product.

LIMITED WARRANTY

As the original purchaser, your Research Products Corporation Aprilaire Room Air Purifier is expressly warranted for one (1) year from the date of purchase to be free from defects in materials or workmanship, except, however, for the disposable filter which will have to be replaced from time to time depending upon usage. Research Products Corporation's exclusive obligation under this warranty shall be to supply, without charge, a replacement for any part of the Room Air Purifier which is found to be defective, or to provide a replacement Room Air Purifier, at the discretion of Research Products Corporation, within such one (1) year period and which is returned not later than thirty (30) days after said one (1) year period by you to Research Products Corporation, PO Box 1467, Madison, WI 53701, together with the dated purchase receipt for the Air Purifier. This warranty is not transferable. IMPLIED WARRANTIES OF MERCHANTABILITY OR FITNESS FOR A PARTICULAR PURPOSE SHALL BE LIMITED IN DURATION TO THE AFORESAID ONE YEAR PERIOD. RESEARCH PRODUCTS CORPORATION'S LIABILITY FOR INCIDENTAL OR CONSEQUENTIAL DAMAGES, OTHER THAN DAMAGES FOR PERSONAL INJURIES, RESULTING FROM ANY BREACH OF THE AFORESAID IMPLIED WARRANTIES OR THE ABOVE LIMITED WARRANTY IS EXPRESSLY EXCLUDED. Some states do not allow limitations on how long an implied warranty lasts or the exclusion or limitation of incidental or consequential damages so the above exclusion or limitations may not apply to you. This warranty gives you specific legal rights and you may also have other rights, which vary from state to state.

Aprilaire[®]

Trusted Solutions for a Healthy Home[®]





Airmilla

Copyright © 2018 Aprilaire - Division of Research Products Corporation. All Rights Reserved.

B2701438A 61001521